

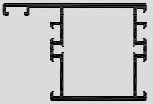

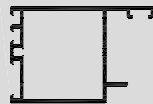

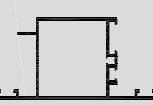

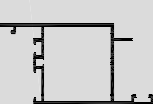

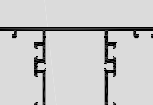
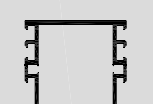
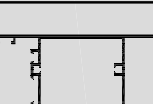
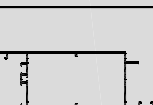
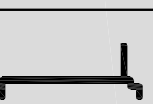
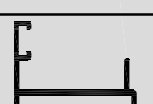

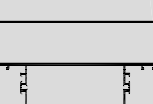
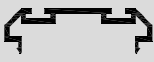

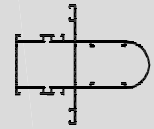











Croquis	Referencia	Denominación	Peso Kg/m.	Perímetro mm.	Inercia Ix cm ⁴	Inercia Iy cm ⁴	Página
	EXL-3006	Marco	1.199	543	11,84	15,41	2-1-1
	EXL-3003	Marco	1.140	492	11,91	16,21	2-1-1
	EXL-3000	Hoja apertura exterior	1.268	563	13,34	23,05	2-1-1
	EXL-3001	Hoja	1.268	563	14,17	23,05	2-1-1
	EXL-3004	Travesaño	1.327	591	13,18	22,13	2-1-1
	EXL-3005	Marco sin pestañas	1.057	465	10,16	9,97	2-1-1
	EXL-3002	Zócalo	1.546	637	17,86	37,97	2-1-2
	EXL-3013	Hoja	1.613	720	20,62	76,25	2-1-2
	EXL-3008	Acople	0.262	116	0,05	1,29	2-1-2
	EXL-3007	Acople	0.597	258	1,92	4,53	2-1-2
	EXL-3010	Zócalo	2.018	812	25,59	116,66	2-1-3
	EXL-3009	Travesaño	1.835	814	21,89	104,35	2-1-3

Croquis	Referencia	Denominación	Peso Kg/m.	Perímetro mm.	Inercia Ix cm ⁴	Inercia Iy cm ⁴	Página
	EXL-3012	Acople puerta vaivén	0.367	188	0,15	3,02	2-1-3
	EXL-3011	Acople puerta vaivén	0.294	153	0,13	2,58	2-1-3
	EXL-3014	Travesaño con tubular	1.998	889	56,67	27,80	2-1-4

HUECOS DE JUNQUILLOS

		 EXL-7637	 EXL-7615	 EXL-7613	 EXL-7614	 EXL-7504	 EXL-7505
		 EXL-4284	 EXL-7634	 EXL-7525	 EXL-7530	 EXL-7724	 EXL-7498
	 EXL-11.285	 EXL-7280	 EXL-7671	 EXL-7281	 EXL-7282	 EXL-7310	 EXL-7361
 EXL-3006	35.5	26.5 26.5 26.5	23.5 23.5 23.5	18.5 18.5 18.5	14.5 14.5 14.5	11.5 11.5 10.5	6 6 6
 EXL-3000	35.5	26.5 26.5 26.5	23.5 23.5 23.5	18.5 18.5 18.5	14.5 14.5 14.5	11.5 11.5 10.5	6 6 6
 EXL-3001	35.5	26.5 26.5 26.5	23.5 23.5 23.5	18.5 18.5 18.5	14.5 14.5 14.5	11.5 11.5 10.5	6 6 6
 EXL-3004	35.5	26.5 26.5 26.5	23.5 23.5 23.5	18.5 18.5 18.5	14.5 14.5 14.5	11.5 11.5 10.5	6 6 6
 EXL-3002	35.5	26.5 26.5 26.5	23.5 23.5 23.5	18.5 18.5 18.5	14.5 14.5 14.5	11.5 11.5 10.5	6 6 6
 EXL-3013	35.5	26.5 26.5 26.5	23.5 23.5 23.5	18.5 18.5 18.5	14.5 14.5 14.5	11.5 11.5 10.5	6 6 6
 EXL-3010	35.5	26.5 26.5 26.5	23.5 23.5 23.5	18.5 18.5 18.5	14.5 14.5 14.5	11.5 11.5 10.5	6 6 6
 EXL-3009	35.5	26.5 26.5 26.5	23.5 23.5 23.5	18.5 18.5 18.5	14.5 14.5 14.5	11.5 11.5 10.5	6 6 6
 EXL-3014	35.5	26.5 26.5 26.5	23.5 23.5 23.5	18.5 18.5 18.5	14.5 14.5 14.5	11.5 11.5 10.5	6 6 6

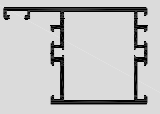
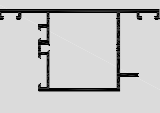
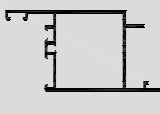
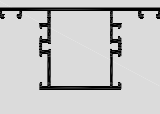
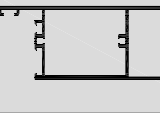
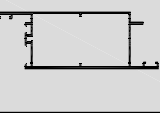
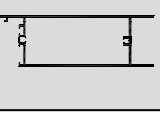
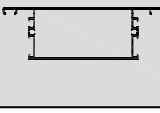
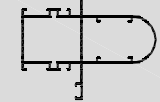
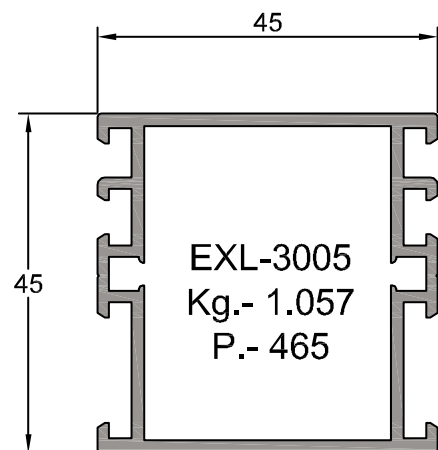
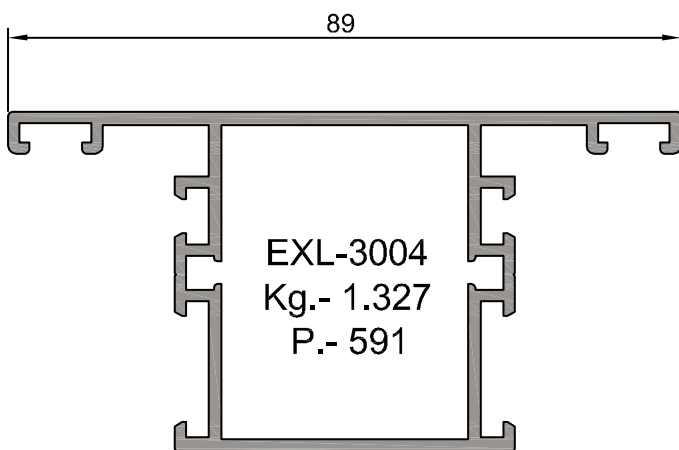
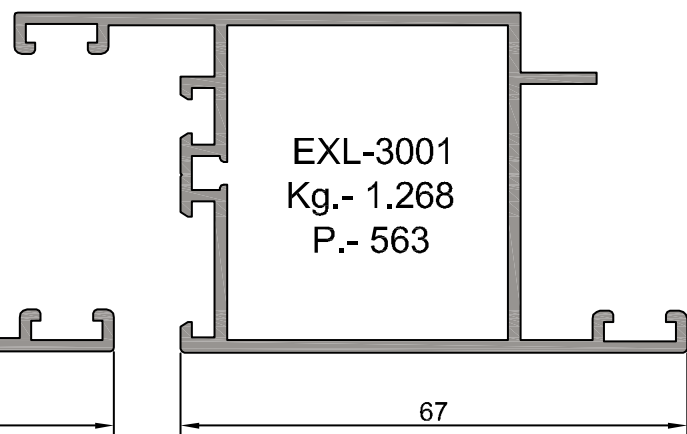
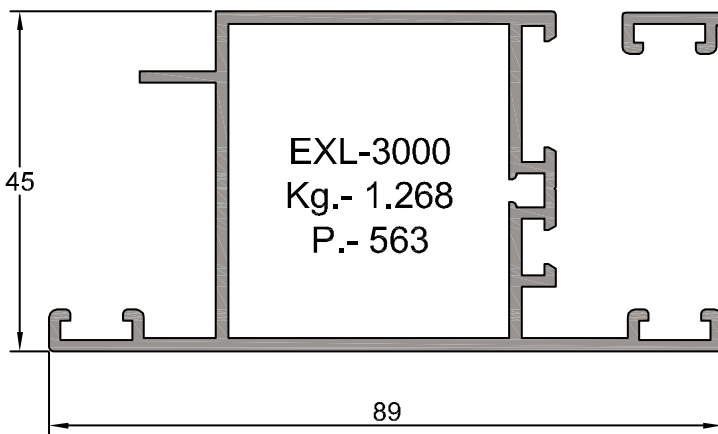
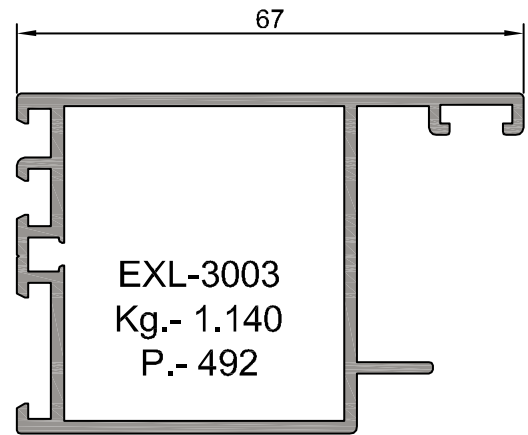
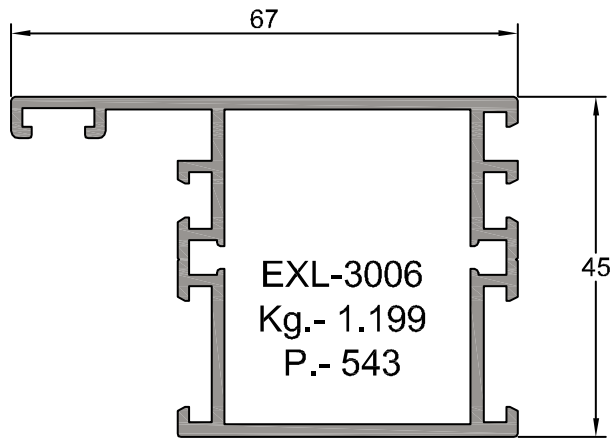

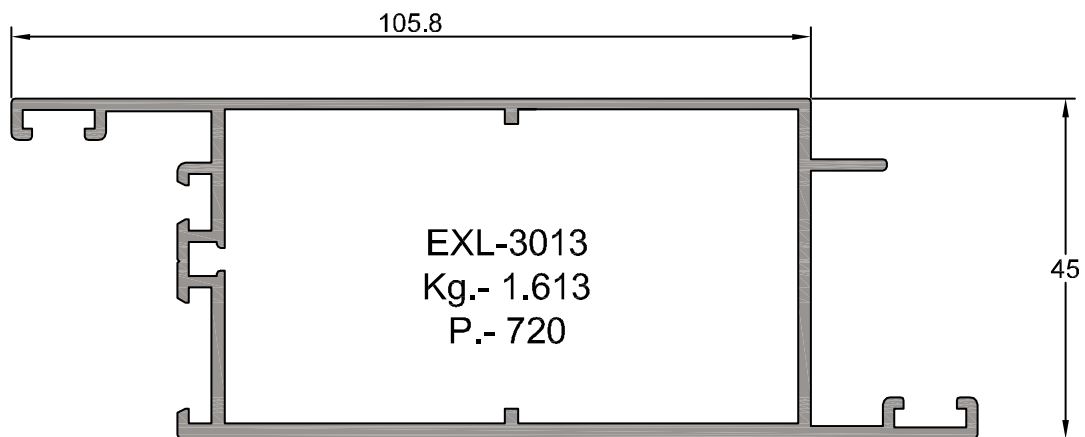
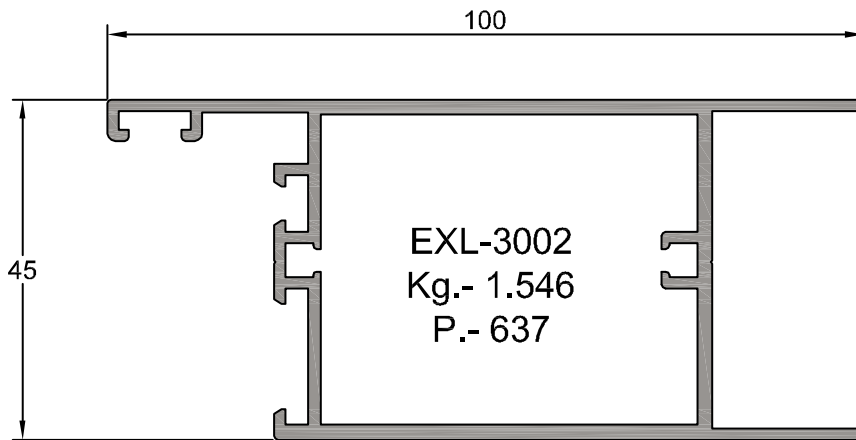

EXL-3008
Kg.- 0.262
P.- 116

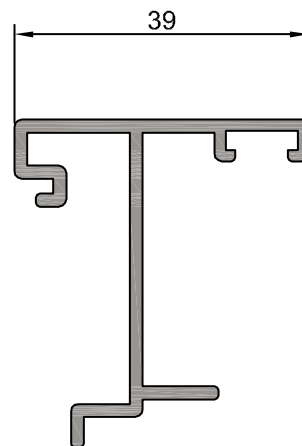
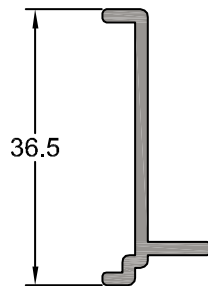

EXL-3007
Kg.- 0.597
P.- 258

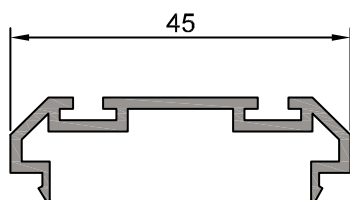
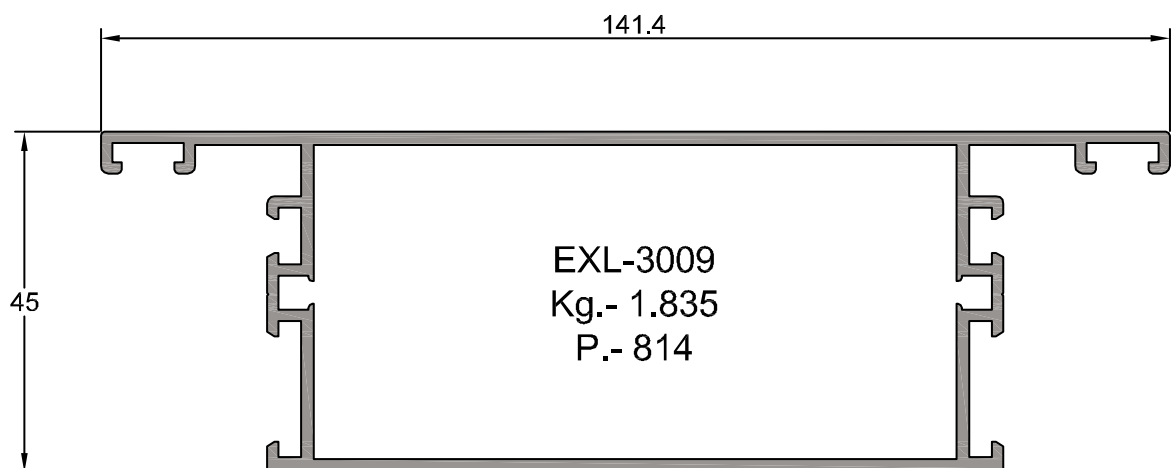
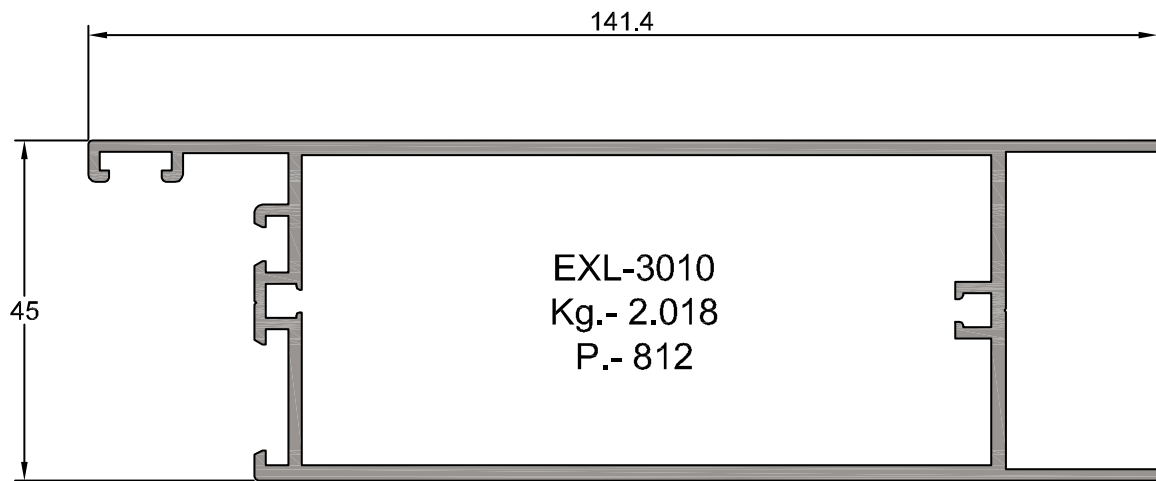

EXL-3012
Kg.- 0.367
P.- 188

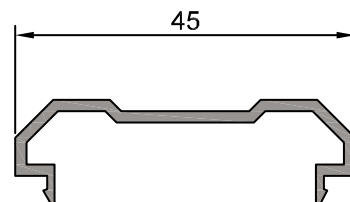

EXL-3011
Kg.- 0.294
P.- 153

