

CARACTERÍSTICAS

Sistema de lamas fijas y móviles.

Perfiles de extrusión de aleación 6063.

Espesor de perfiles de 1.3 mm y 1.4 mm.

Juntas de estanqueidad en E.P.D.M.

Escuadras de unión de aluminio inyectado con muelle de tetón.

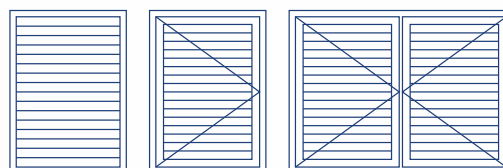
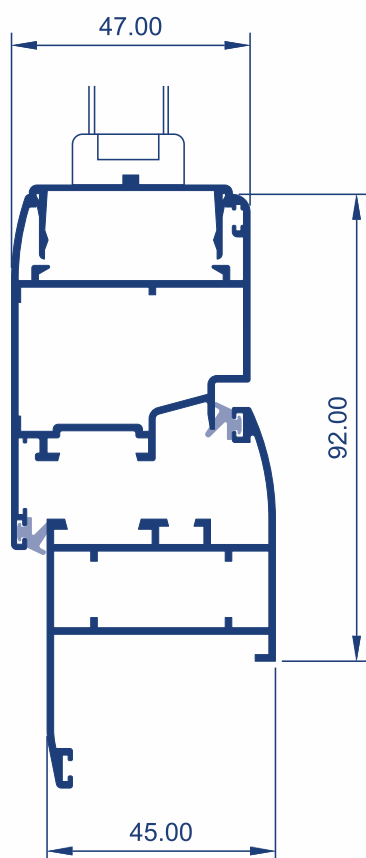

Fijo





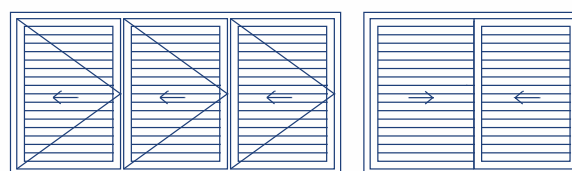























Abatible
apertura interior

Abatible
apertura interior 2 hojas



Plegable

Corredera

| Referencia | Sección | Designación | Peso g / ml | Perímetro dm2 / ml | Inercia Ix cm4 | Inercia Iy cm4 |
|------------|---|----------------------------------|----------------|-----------------------|-------------------|-------------------|
| 210 |  | Lama fija | 313 | 22.0 | | |
| 211 |  | Lama móvil | 513 | 34.6 | | |
| 212 |  | Lama compensadora | 395 | 26.7 | | |
| 2011 |  | Marco recto | 659 | 37.0 | 5.4932 | 3.6773 |
| 2012 |  | Marco curvo | 737 | 40.8 | 7.2013 | 4.4696 |
| 2013 |  | Marco curvo con resalte | 810 | 44.8 | 11.2046 | 4.7619 |
| 2014 |  | Marco recto puerta | 745 | 41.8 | 6.6811 | 7.5319 |
| 2015 |  | Marco curvo puerta | 802 | 44.4 | 8.6370 | 8.7243 |
| 2022 |  | Travesaño de 72 mm | 813 | 45.5 | 6.3427 | 7.0435 |
| 2023 |  | Travesaño de 84 mm | 898 | 50.3 | 7.5707 | 12.7711 |
| 2046 |  | Inversor recto | 845 | 45.2 | 6.7711 | 6.5828 |
| 2047 |  | Inversor curvo | 899 | 47.5 | 8.3394 | 7.2929 |
| 2050 |  | Adaptador | 281 | 17.6 | 0.4156 | 1.3014 |
| 2052 |  | Hoja ventana | 896 | 50.2 | 10.2637 | 9.8550 |
| 2054 |  | Zócalo | 1267 | 60.5 | 13.2156 | 41.6416 |
| 2055 |  | Hoja puerta | 1091 | 54.9 | 13.3265 | 18.9327 |
| 2062 |  | Marco curvo con solape | 845 | 46.4 | 9.1780 | 8.9199 |
| 5070 |  | Terminal de lamas | 265 | 16.1 | 0.3509 | 1.1773 |
| 5111 |  | Hoja corredera | 948 | 45.6 | 8.6309 | 12.2969 |
| 5334 |  | Hoja plegable para cristal | 1050 | 50.5 | 9.0265 | 16.1796 |
| 5335 |  | Marco | 832 | 42.0 | 9.7855 | 3.8711 |
| 5336 |  | Guía superior de empotrar | 1199 | 43.3 | 12.7863 | 8.6499 |
| 5337 |  | Inversor doble hoja | 219 | 10.7 | 0.1749 | 0.3154 |
| 5338 |  | Tapa decorativa guía sup. superp | 680 | 34.0 | 9.4039 | 19.6815 |
| 5340 |  | Guía superior superpuesta | 1823 | 50.8 | 10.5513 | 48.8575 |
| 5341 |  | Tapa lateral | 540 | 22.8 | 0.7983 | 9.9473 |
| 5342 |  | Guía inferior empotrada | 362 | 18.0 | 0.8546 | 1.8096 |
| 5343 |  | Guía inferior superpuesta | 567 | 28.2 | 1.0116 | 11.5390 |

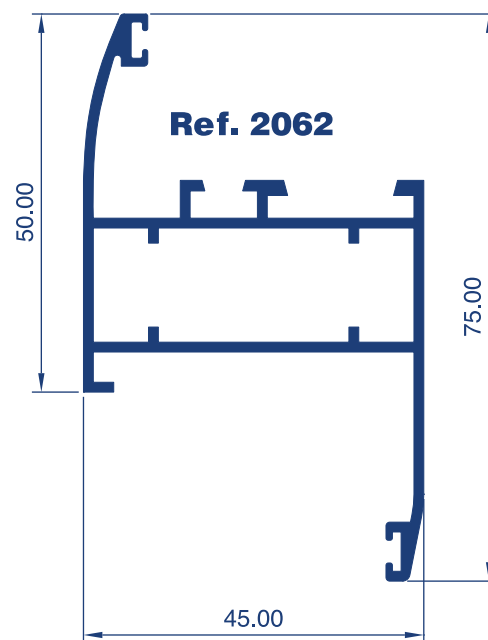
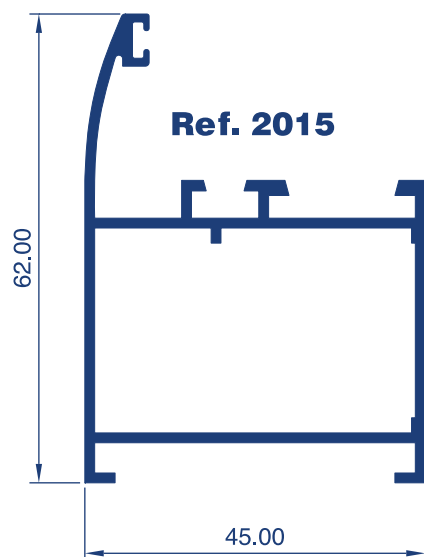
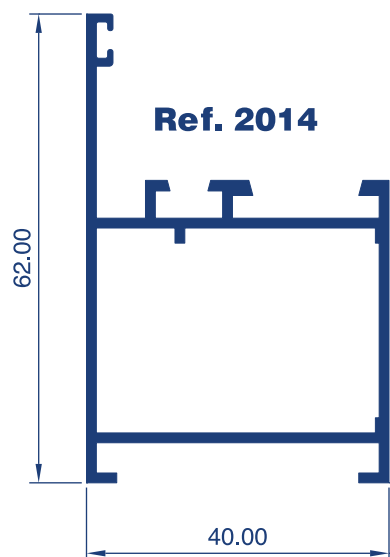
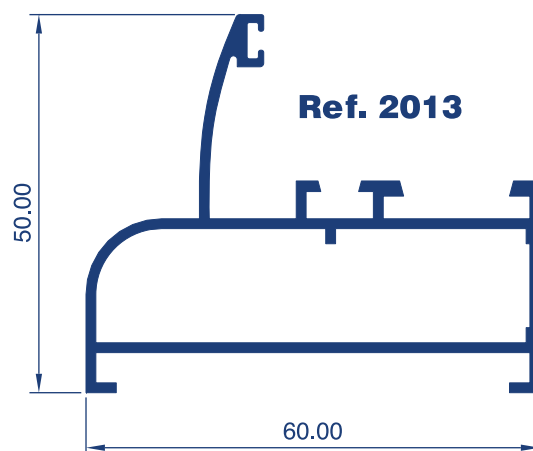
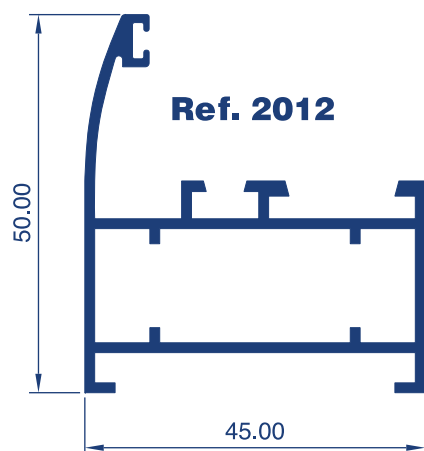
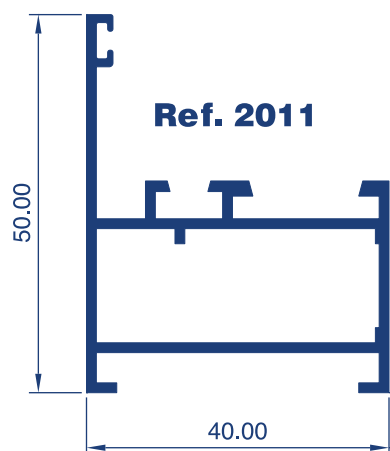

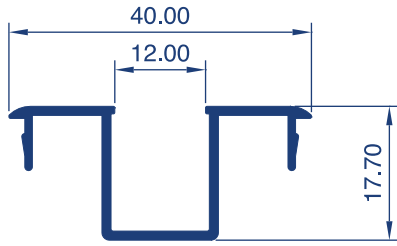

Ref. 2050

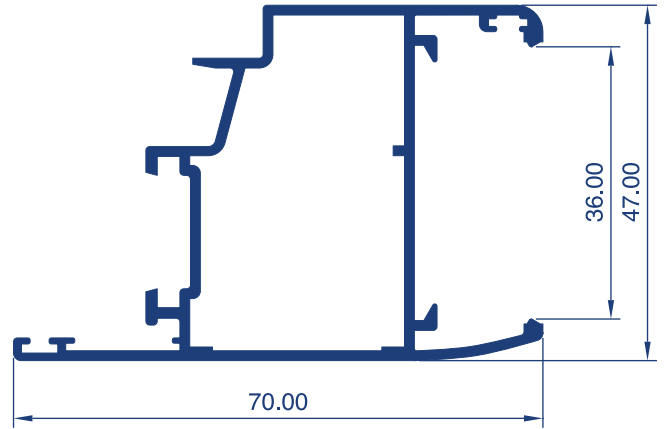

Ref. 2052



Ref. 211

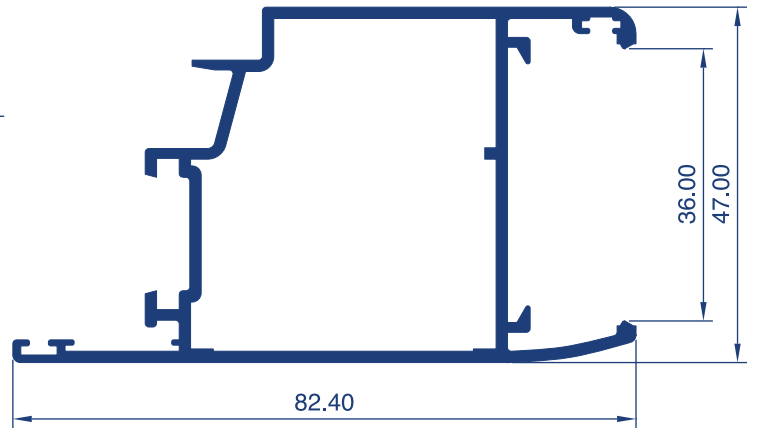

Ref. 2055

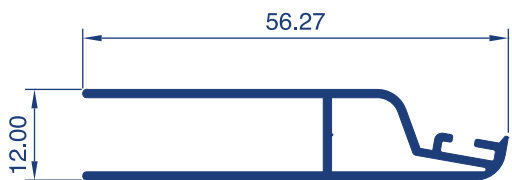

Ref. 212

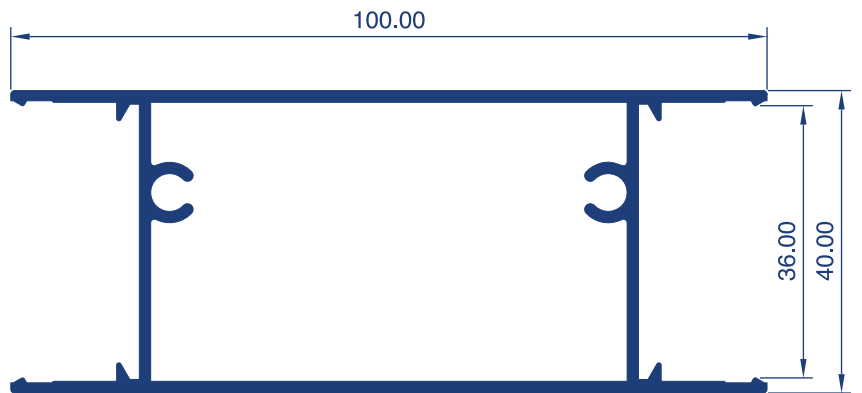

Ref. 2054

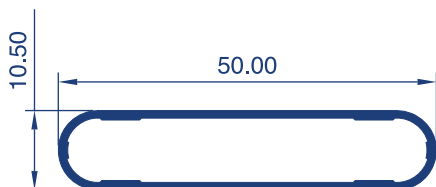

Ref. 210

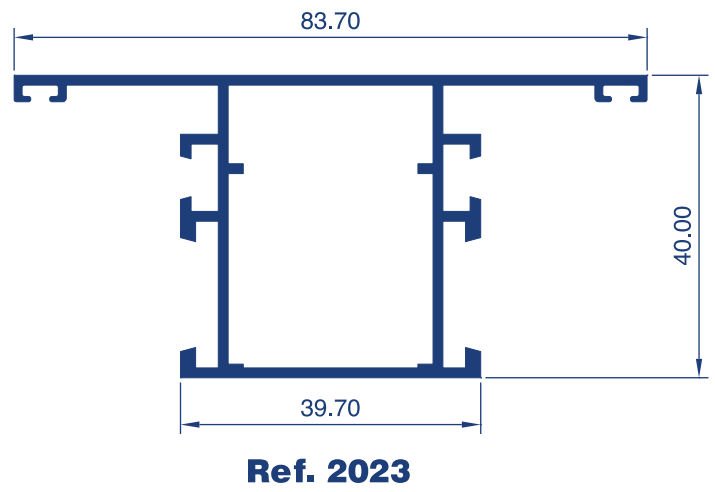
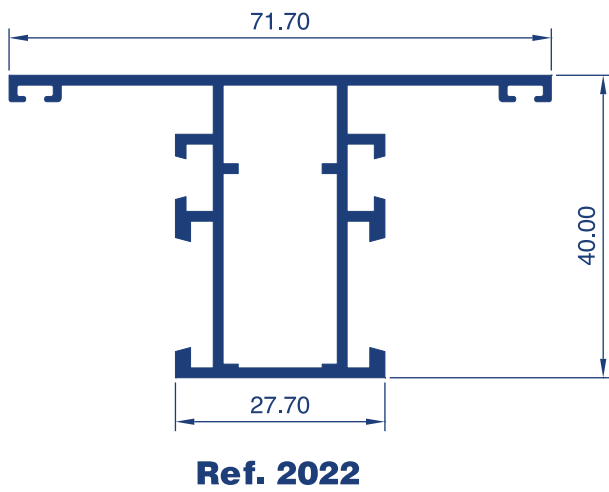
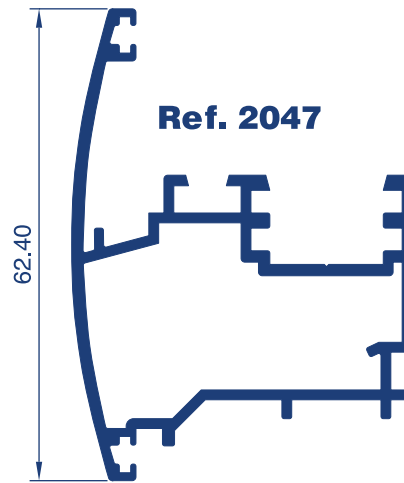
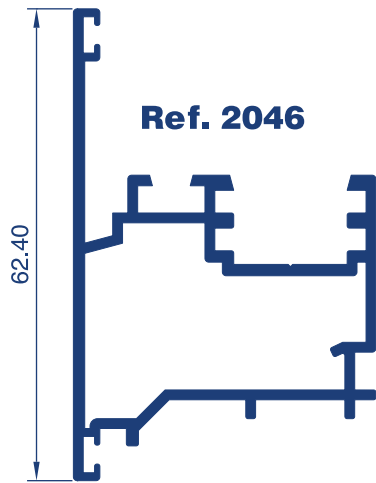

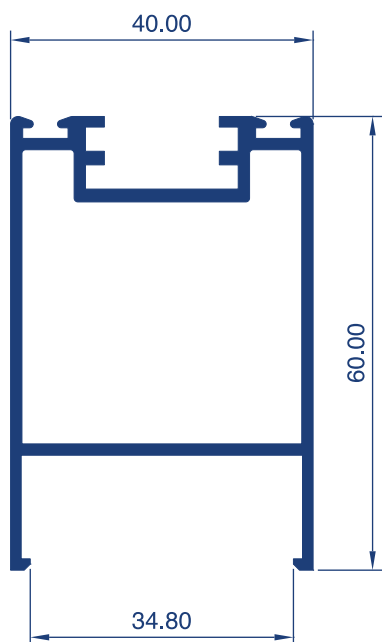
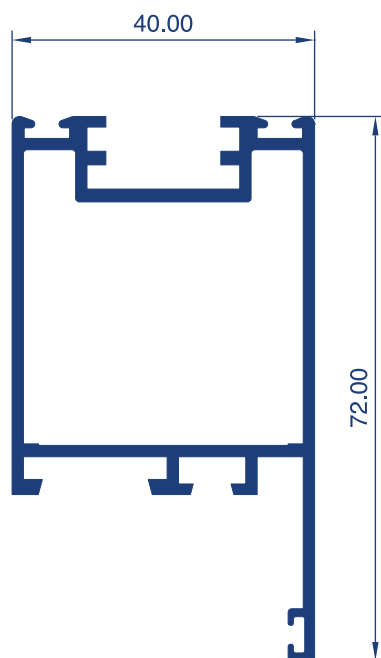
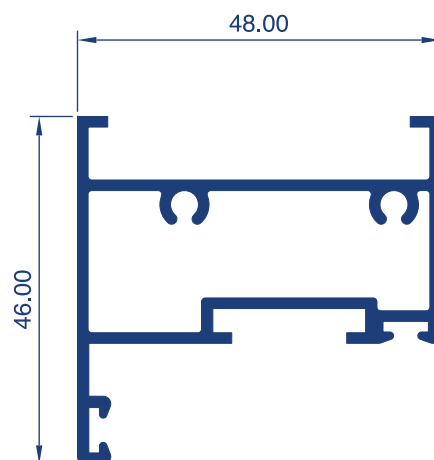
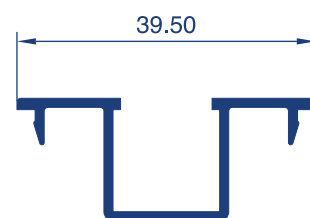
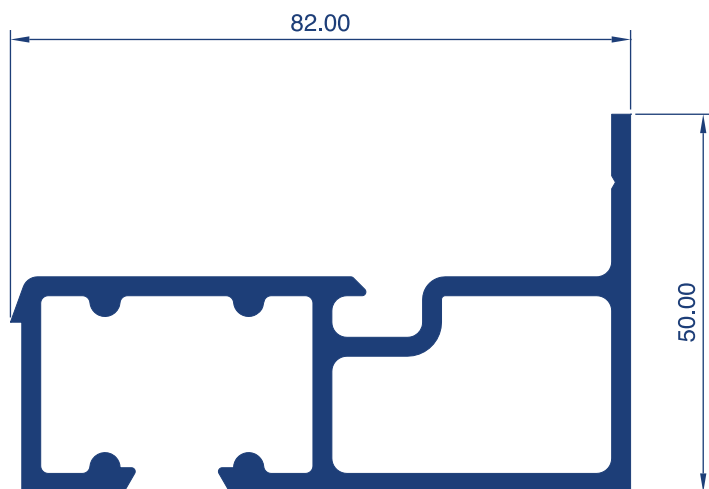
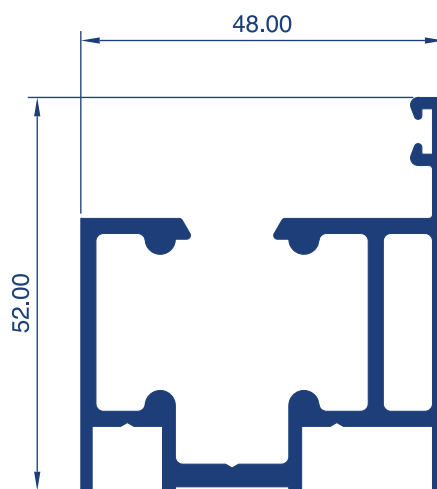
**Ref. 5111****Ref. 5334****Ref. 5335****Ref. 5070****Ref. 5340****Ref. 5336**

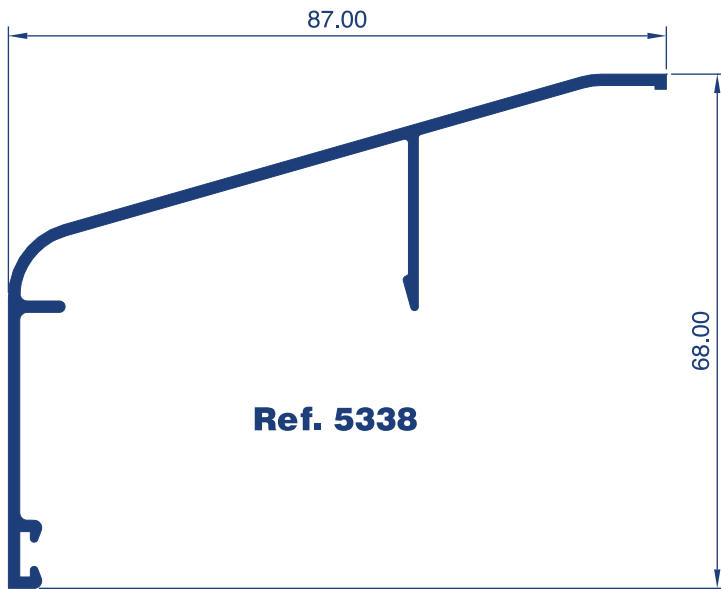

Ref. 5338

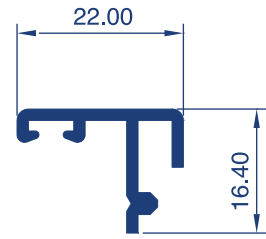

Ref. 5337

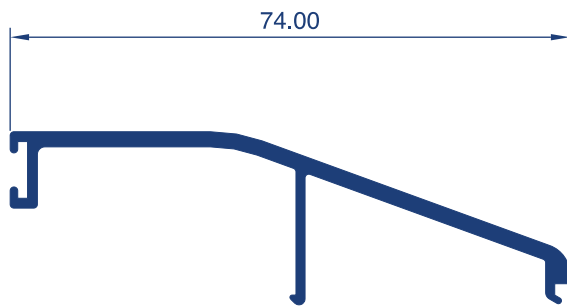

Ref. 5341

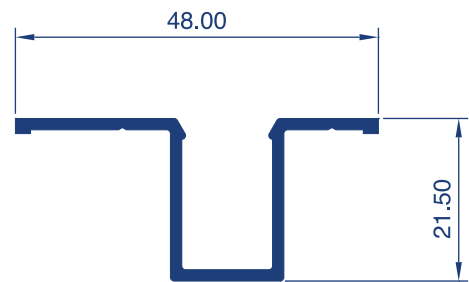



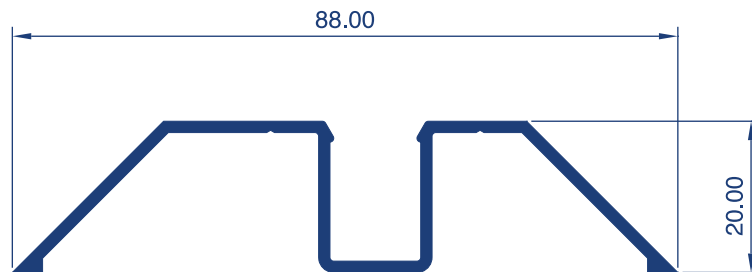





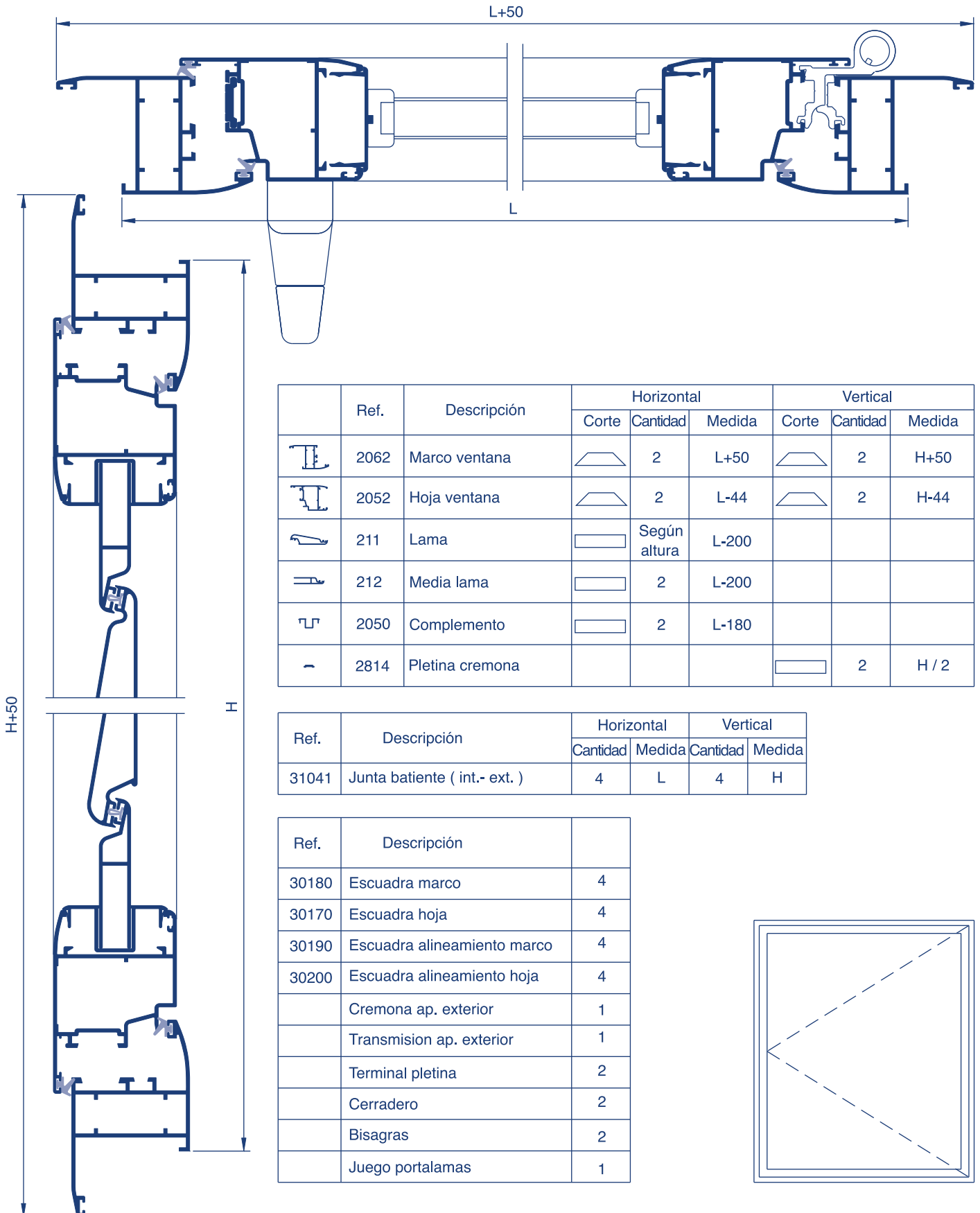





Ref. 5342



Ref. 5343

Ventana 1 hoja



| | Ref. | Descripción | Horizontal | | | Vertical | | |
|---|------|-----------------|---|--------------|--------|---|----------|--------|
| | | | Corte | Cantidad | Medida | Corte | Cantidad | Medida |
|  | 2062 | Marco ventana |  | 2 | L+50 |  | 2 | H+50 |
|  | 2052 | Hoja ventana |  | 2 | L-44 |  | 2 | H-44 |
|  | 211 | Lama |  | Según altura | L-200 | | | |
|  | 212 | Media lama |  | 2 | L-200 | | | |
|  | 2050 | Complemento |  | 2 | L-180 | | | |
|  | 2814 | Pletina cremona | | | |  | 2 | H / 2 |





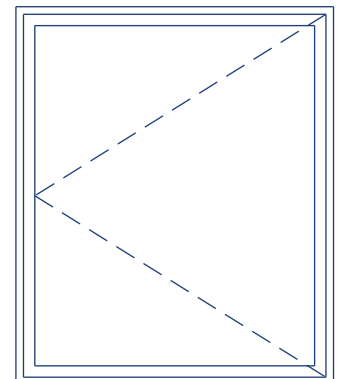



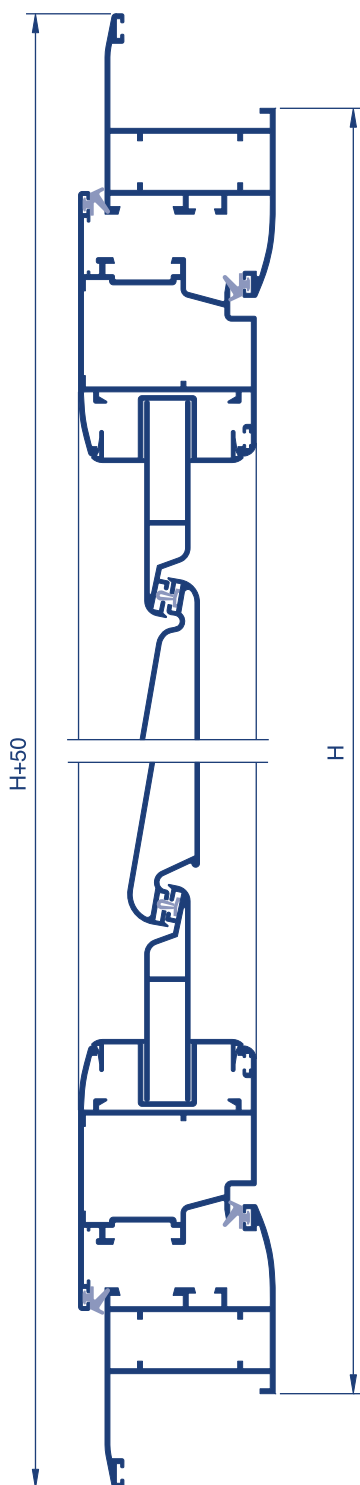
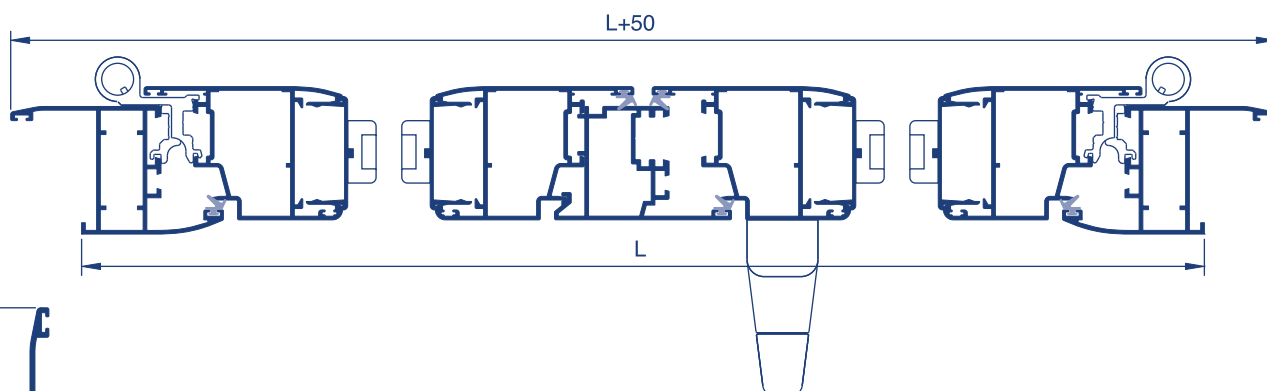



| Ref. | Descripción | Horizontal | | Vertical | |
|-------|-------------------------------|------------|--------|----------|--------|
| | | Cantidad | Medida | Cantidad | Medida |
| 31041 | Junta batiente (int.- ext.) | 4 | L | 4 | H |

| Ref. | Descripción | |
|-------|-----------------------------|---|
| 30180 | Escuadra marco | 4 |
| 30170 | Escuadra hoja | 4 |
| 30190 | Escuadra alineamiento marco | 4 |
| 30200 | Escuadra alineamiento hoja | 4 |
| | Cremona ap. exterior | 1 |
| | Transmision ap. exterior | 1 |
| | Terminal pletina | 2 |
| | Cerradero | 2 |
| | Bisagras | 2 |
| | Juego portalamas | 1 |



Ventana 2 hojas









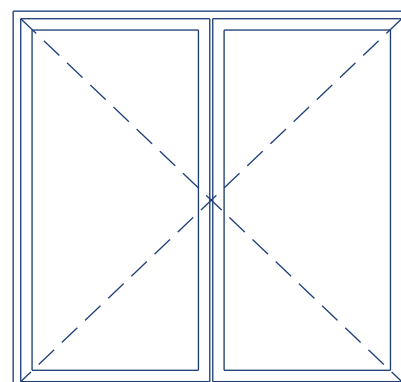

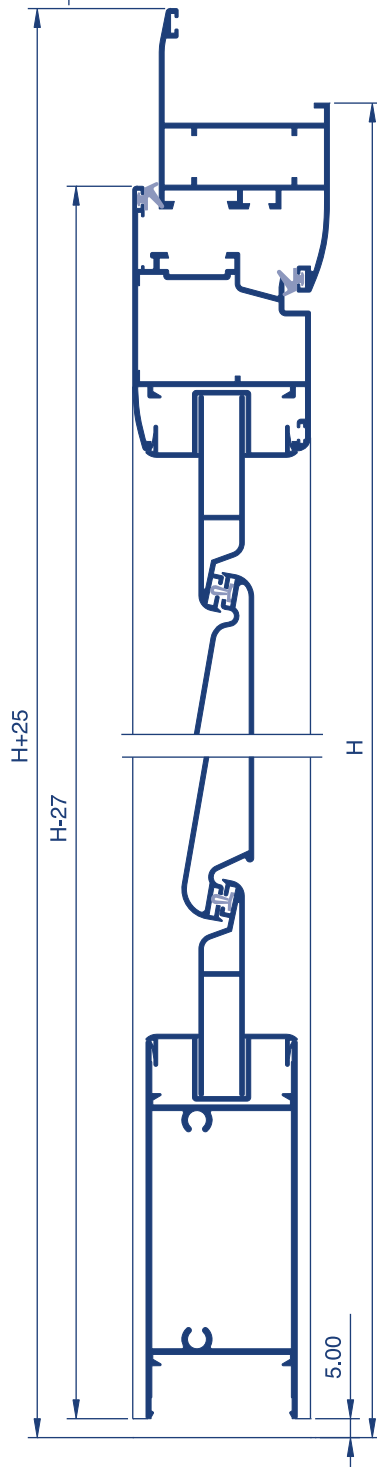
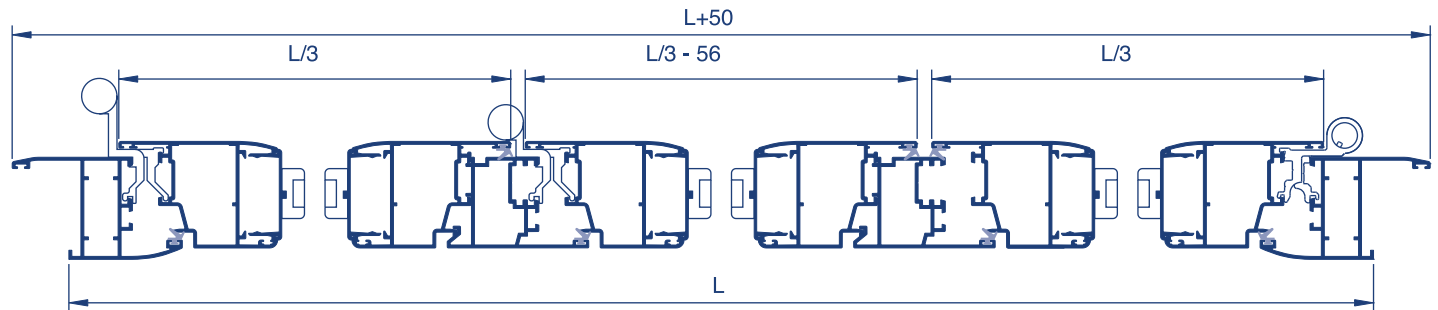







| | Ref. | Descripción | Horizontal | | | Vertical | | |
|---|------|-----------------|---|--------------|-----------|---|----------|---------|
| | | | Corte | Cantidad | Medida | Corte | Cantidad | Medida |
|  | 2062 | Marco ventana |  | 2 | L+50 |  | 2 | H+50 |
|  | 2052 | Hoja ventana |  | 4 | L/2 - 25 |  | 4 | H-44 |
|  | 2047 | Inversor | | | |  | 1 | H - 113 |
|  | 211 | Lama |  | Según altura | L/2 - 181 | | | |
|  | 212 | Media lama |  | 2 | L/2 - 181 | | | |
|  | 2050 | Complemento |  | 2 | L/2 - 165 | | | |
|  | 2814 | Pletina cremona | | | |  | 2 | H / 2 |

| Ref. | Descripción | Horizontal | | Vertical | |
|-------|-------------------------------|------------|--------|----------|--------|
| | | Cantidad | Medida | Cantidad | Medida |
| 31041 | Junta batiente (int.- ext.) | 4 | L | 7 | H |

| Ref. | Descripción | |
|-------|-----------------------------|---|
| 30180 | Escuadra marco | 4 |
| 30170 | Escuadra hoja | 8 |
| 30190 | Escuadra alineamiento marco | 4 |
| 30200 | Escuadra alineamiento hoja | 8 |
| 30440 | Juego tapas inversor | 1 |
| | Cremona ap. exterior | 1 |
| | Transmision ap. exterior | 1 |
| | Terminal pletina | 2 |
| | Cerradero | 2 |
| | Bisagras | 4 |
| | Juego portalamas | 2 |



Puerta 3 hojas

| | Ref. | Descripción | Horizontal | | | Vertical | | |
|---|------|--|---|--------------|-----------------|---|----------|---------|
| | | | Corte | Cantidad | Medida | Corte | Cantidad | Medida |
|  | 2062 | Marco ventana |  | 2 | L+50 |  | 2 | H+50 |
|  | 2052 | Hoja lateral ventana Hoja central ventana |  | 4 2 | L/3 L/3 - 56 |  | 6 | H-44 |
|  | 2047 | Inversor | | | |  | 2 | H - 113 |
|  | 211 | Lama |  | Según altura | L/2 - 181 | | | |
|  | 212 | Media lama |  | 2 | L/2 - 181 | | | |
|  | 2050 | Complemento |  | 2 | L/2 - 165 | | | |
|  | 2814 | Pletina cremona | | | |  | 2 | H / 2 |

| Ref. | Descripción | Horizontal | | Vertical | |
|-------|-------------------------------|------------|--------|----------|--------|
| | | Cantidad | Medida | Cantidad | Medida |
| 31041 | Junta batiente (int.- ext.) | 4 | L | 7 | H |

| Ref. | Descripción | |
|-------|-----------------------------|---|
| 30180 | Escuadra marco | 4 |
| 30170 | Escuadra hoja | 8 |
| 30190 | Escuadra alineamiento marco | 4 |
| 30200 | Escuadra alineamiento hoja | 8 |
| 30440 | Juego tapas inversor | 1 |
| | Cremona ap. exterior | 1 |
| | Transmision ap. exterior | 1 |
| | Terminal pletina | 2 |
| | Cerradero | 2 |
| | Bisagras | 4 |
| | Juego portalamas | 2 |

